







# P7\_Indianska

	 20 min	
--	--	--

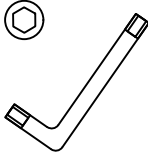
<b>A</b> x18 8x40 	<b>V</b> x8 M6x80 	<b>X</b> x10 7x70 
---	---	---

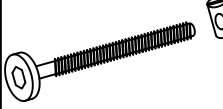
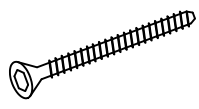
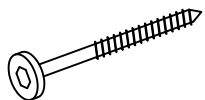
<b>Y.2</b> x2 M6.5x90 	<b>U.1</b> x23 4x45mm 
--	---

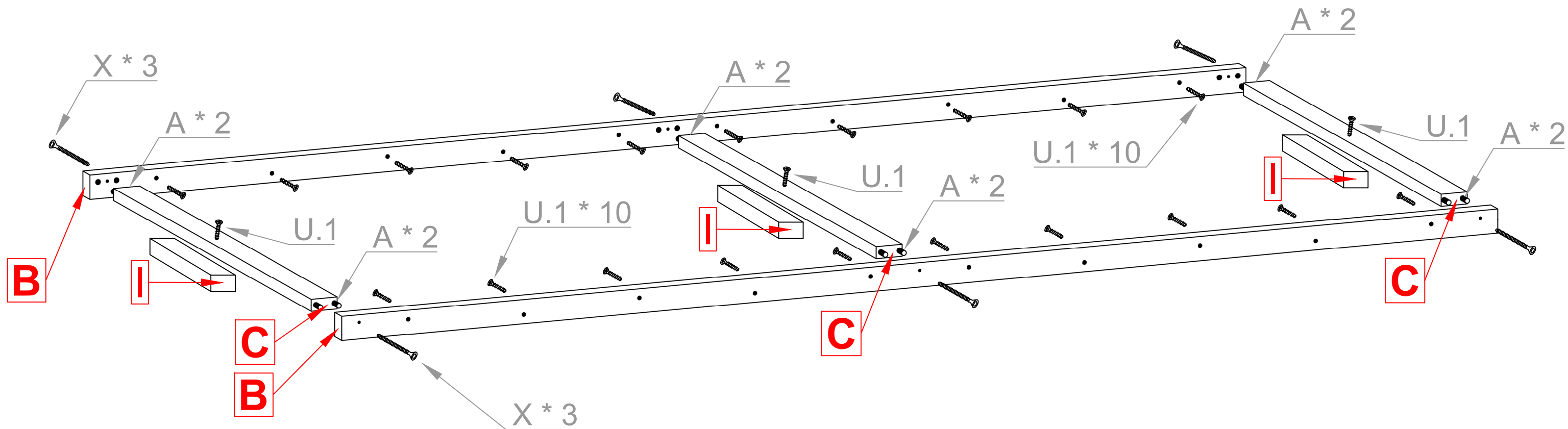

# P7\_Indianska

